

1949-1954 Chevy Car Coil-Spring Front End Installation Instructions

Tech line: 1-855-693-1259 www.totalcostinvolved.com

Read and understand these instructions before starting any work!

**USE THE PARTS LIST BELOW TO MAKE SURE YOUR KIT IS COMPLETE BEFORE INSTALLATION.
IF ANY PIECES ARE MISSING, PLEASE CONTACT: Total Cost Involved Engineering 855-693-1259**

Thank you for choosing TCI Engineering's Coil Spring Front Suspension package. This kit features our completely new upper spring towers that allow traditional shims/washers for alignment adjustments. This design eliminates the T-bolt design that was prone to slipping and throwing your alignment out when you hit potholes. This new kit also features our new 7/8" anti-sway bar which is stiffer than the 3/4" previously offered.

New Coil-Spring Front End on Original Stock Chassis



1949-1954 Chevy Car Coil-Spring Front End Parts List –

Part#: * 224-2354-0cp-c3k-1ex or 224-2354-0sm-a6k-4qx – The asterisk shown is the plain/standard package

1	Coil-Spring Cross member	1	Rack & Pinion – Only
	<ul style="list-style-type: none"> 1949-1954 Chevy Car Part #: 224-2356-00 		<ul style="list-style-type: none"> Power Rack Part #: 304-3215-00 + 1 in. *Manual Rack Part #: 304-3205-00 + 1 in.
2	Upper Control Arms	1	Rack & Pinion Bolt Kit – Hardware
	<ul style="list-style-type: none"> * Part #: 200-2257-00 – Plain Part #: 200-2257-05 – Black Part #: 200-2257-02 – Polished 		<ul style="list-style-type: none"> Power Rack Part #: 300-3233-00 *Manual Part #: 300-3231-00
2	Lower Control Arms	1	Tie Rod Ends Set – Hardware
	<ul style="list-style-type: none"> * Part #: 200-2257-00 – Coil-Spring - Plain 		<ul style="list-style-type: none"> Part #: 301-3238-00
	<ul style="list-style-type: none"> * Part #: 200-2257-05 – Coil-Spring - Black Part #: 200-2257-02 – Coil-Spring - Polished Part #: 200-2457-00 – Air Bag – Plain Part #: 200-2457-05 – Air Bag - Black Part #: 200-2457-02 – Air Bag - Polished Part #: 200-2557-00 – Coil-Over – Plain Part #: 200-2557-05 – Coil-Over – Black 	2	Assembled: Drop Spindle w/11" Rotors and Calipers BP: 4.5 Part# spasyspb11pad-gmn or BP: 4.75 spasyrpb10daf-gmp
	<ul style="list-style-type: none"> * Part #: 200-2257-05 – Coil-Spring - Black Part #: 200-2257-02 – Coil-Spring - Polished Part #: 200-2457-00 – Air Bag – Plain Part #: 200-2457-05 – Air Bag - Black Part #: 200-2457-02 – Air Bag - Polished Part #: 200-2557-00 – Coil-Over – Plain Part #: 200-2557-05 – Coil-Over – Black 	2	Sway Bar and Mount – Hardware
	<ul style="list-style-type: none"> Part #: 200-2457-00 – Air Bag – Plain Part #: 200-2457-05 – Air Bag - Black Part #: 200-2457-02 – Air Bag - Polished Part #: 200-2557-00 – Coil-Over – Plain Part #: 200-2557-05 – Coil-Over – Black 		<ul style="list-style-type: none"> Part #: swaybar-f09-pln (BAR/PLAIN) Part #: swaybar-f09-crm (BAR/CHROME) Part #: swy-bar-mnt-032-pln Part #: swy-bar-heims38mod - 3/8 Modified Heims Part #: swy-bar-bolt-01-pln
	<ul style="list-style-type: none"> Part #: 200-2457-00 – Air Bag – Plain Part #: 200-2457-05 – Air Bag - Black Part #: 200-2457-02 – Air Bag - Polished Part #: 200-2557-00 – Coil-Over – Plain Part #: 200-2557-05 – Coil-Over – Black 	2	Shocks Painted Body - Part#: skbdy09-5 Coil Springs – 300# black powder coated Billet Coilovers - Part#: skbdy03-0
	<ul style="list-style-type: none"> Part #: 200-2457-00 – Air Bag – Plain Part #: 200-2457-05 – Air Bag - Black Part #: 200-2457-02 – Air Bag - Polished Part #: 200-2557-00 – Coil-Over – Plain Part #: 200-2557-05 – Coil-Over – Black 	2	Sway Bar and Mount – Hardware 3/8 Bolt Kit
	<ul style="list-style-type: none"> Part #: 200-2457-00 – Air Bag – Plain Part #: 200-2457-05 – Air Bag - Black Part #: 200-2457-02 – Air Bag - Polished Part #: 200-2557-00 – Coil-Over – Plain Part #: 200-2557-05 – Coil-Over – Black 	2	Coil-Springs - Black Powder Coated - Part#: spring600b for coil over or springm300b for regular coil spring

~ New Coil-Spring Front End ~

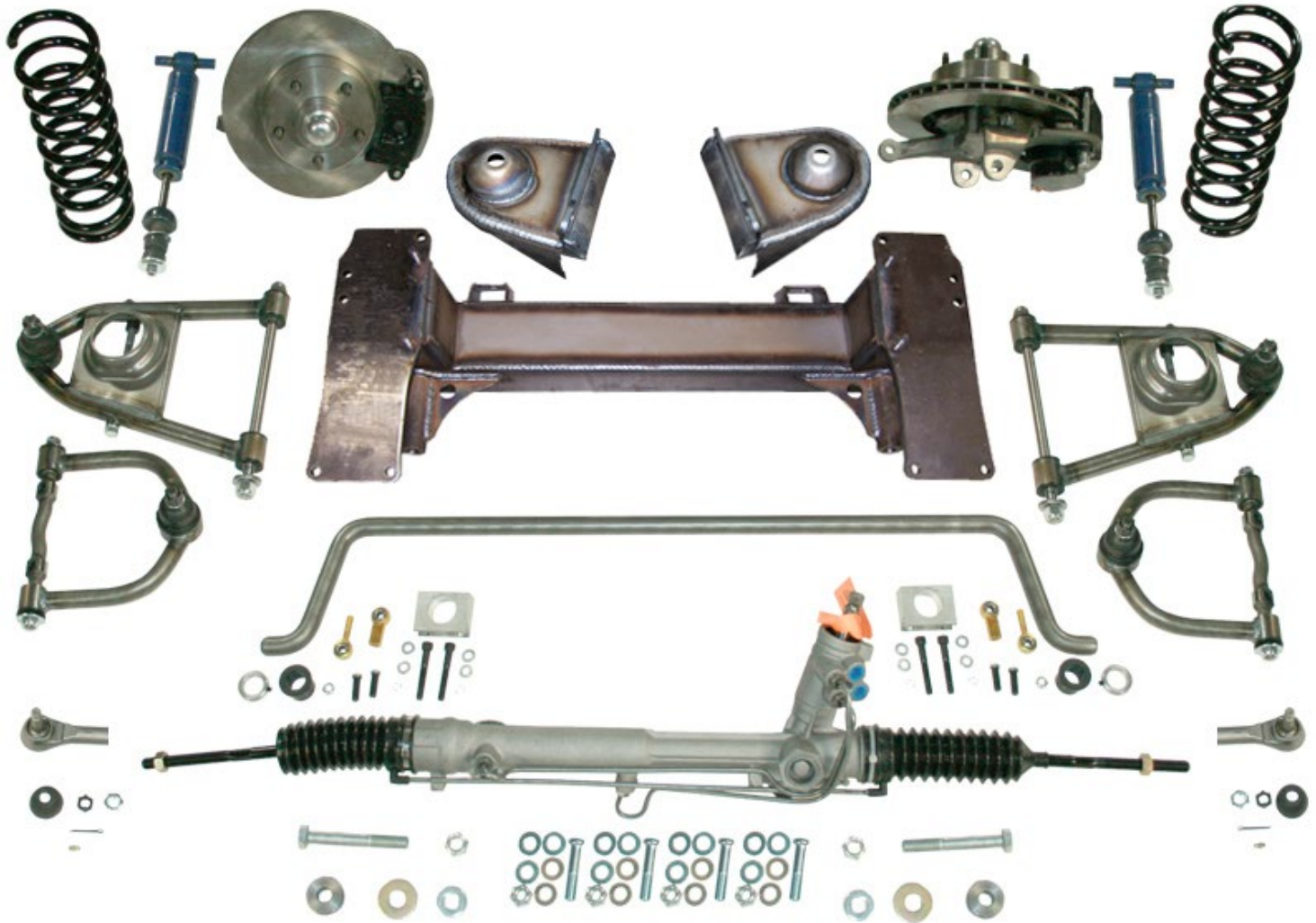

***NOTE:** The following manual assumes the factory suspension has already been removed.

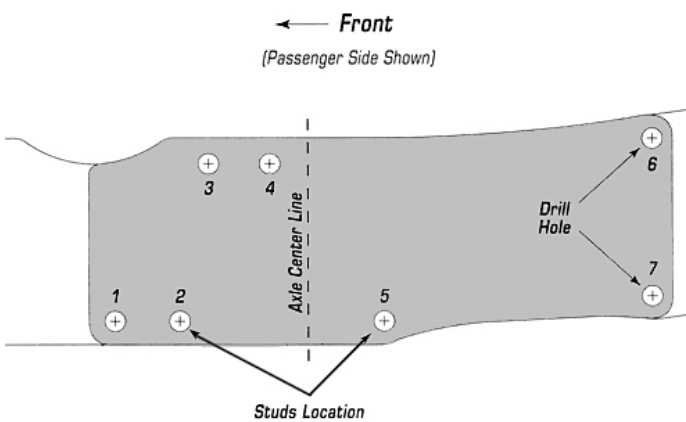

Installing the cross member:

Holes #2 & #5 will have studs pre-installed onto the flat plates of the cross member. These studs will match up to pre-existing holes on the factory frame. This will position the cross member exactly where it needs to be.

NOTE Holes #1, #3 & #4 also have pre-existing holes matching on the factory frame but these will use a regular nut & bolt instead of a stud. Holes #6 & #7 will have to be drilled through the frame.

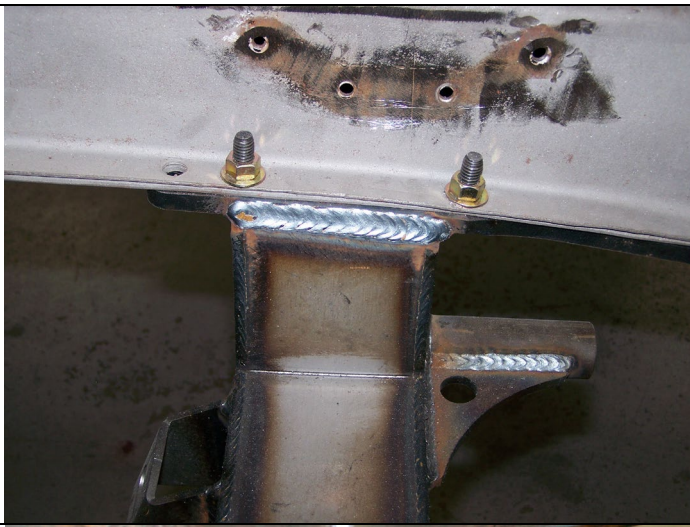

Push the cross member up into place with the rack & pinion brackets towards the front of the vehicle. Install the 3/8" nuts onto the 4 studs. Slowly tighten each nut making sure the cross member pulls up evenly against the bottom of the frame rail. Torque to 45 ft lbs.

Now that the cross member is held into place you can use a 3/8" drill bit for holes #6 & #7 on both driver and passenger sides of the chassis.

Install the remaining 3/8" hardware and torque to 45 ft lbs.



Installing the lower control arms:

NOTE The acorn side of the 5/8" shaft faces forward.

The arrows in the picture denote where the washers are used. There is no washer placed against the front side of the cross member. There are only 3 washers used per side of the vehicle. Install the 5/8" full nylock nut on the back side of the shaft and torque to 75 ft. lbs.

NOTE Driver side control arm is pictured

49-54 CHEVY CAR COIL SPRING

UPPER CONTROL ARM MOUNTING PLATE OUTSIDE / OUTSIDE MEASUREMENT

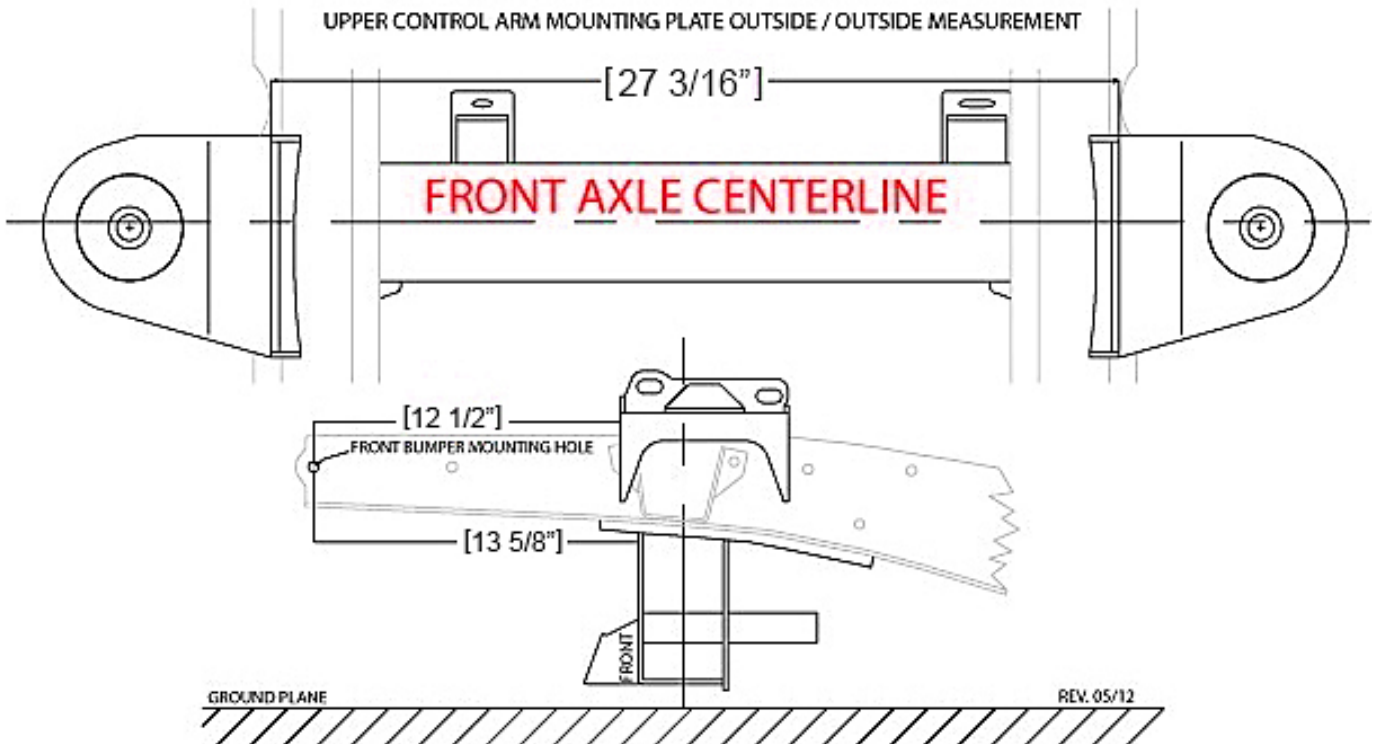



Installing the spring towers:

You will need to remove the front portion of this frame bracket for the coil spring towers to be installed.

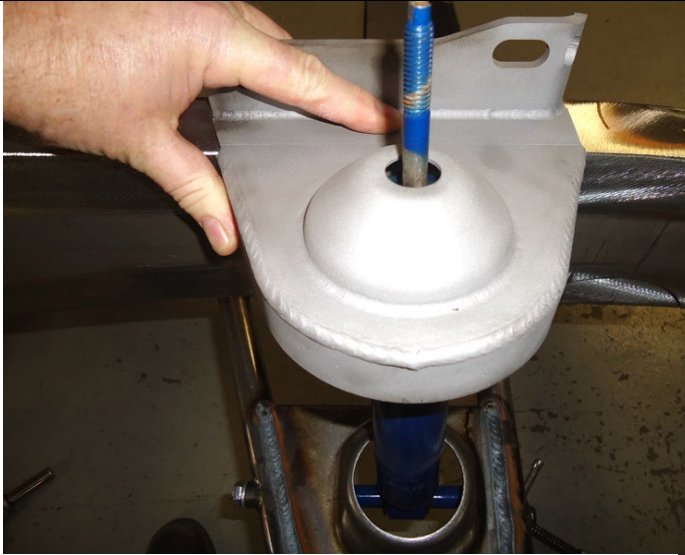

Installing the spring towers:

The tall part of the control arm mount goes towards the front of the car. This is the built-in anti-dive. Follow the measurements in the illustration above for exact placement of the towers side to side & front to back. It will be critical that the towers are installed square and parallel to each other at $27 \frac{3}{16}'' \pm \frac{1}{16}''$ apart outside to outside of arm mount faces. Also, the arm mount face must be vertical $\pm .5$ degrees. This will insure proper alignment. It may be necessary to grind some material off the towers where they come up against the side of the frame to achieve the proper measurement. As a reference, install the shock onto the lower control arm and pull the shock shaft through the upper spring tower hole. The shock shaft should line up directly with the hole in the cone when everything is correct.



Once proper placement of the spring towers have been confirmed place a couple tack welds at the top and the side of the tower/frame.

Double check all measurements.

Now the spring towers can be welded in place.

NOTE Driver's side pictured

Coil Spring Installation

Helpful Hints For Installing Springs

We suggest that you wait until final vehicle assembly (vehicle at full weight) to install the coil springs because it will put undue stress on the ball joints and could cause the boots to tear. Another option is to remove the upper and lower ball joint boots and then cover the ball joints to keep dirt out until you're ready to drive the vehicle.

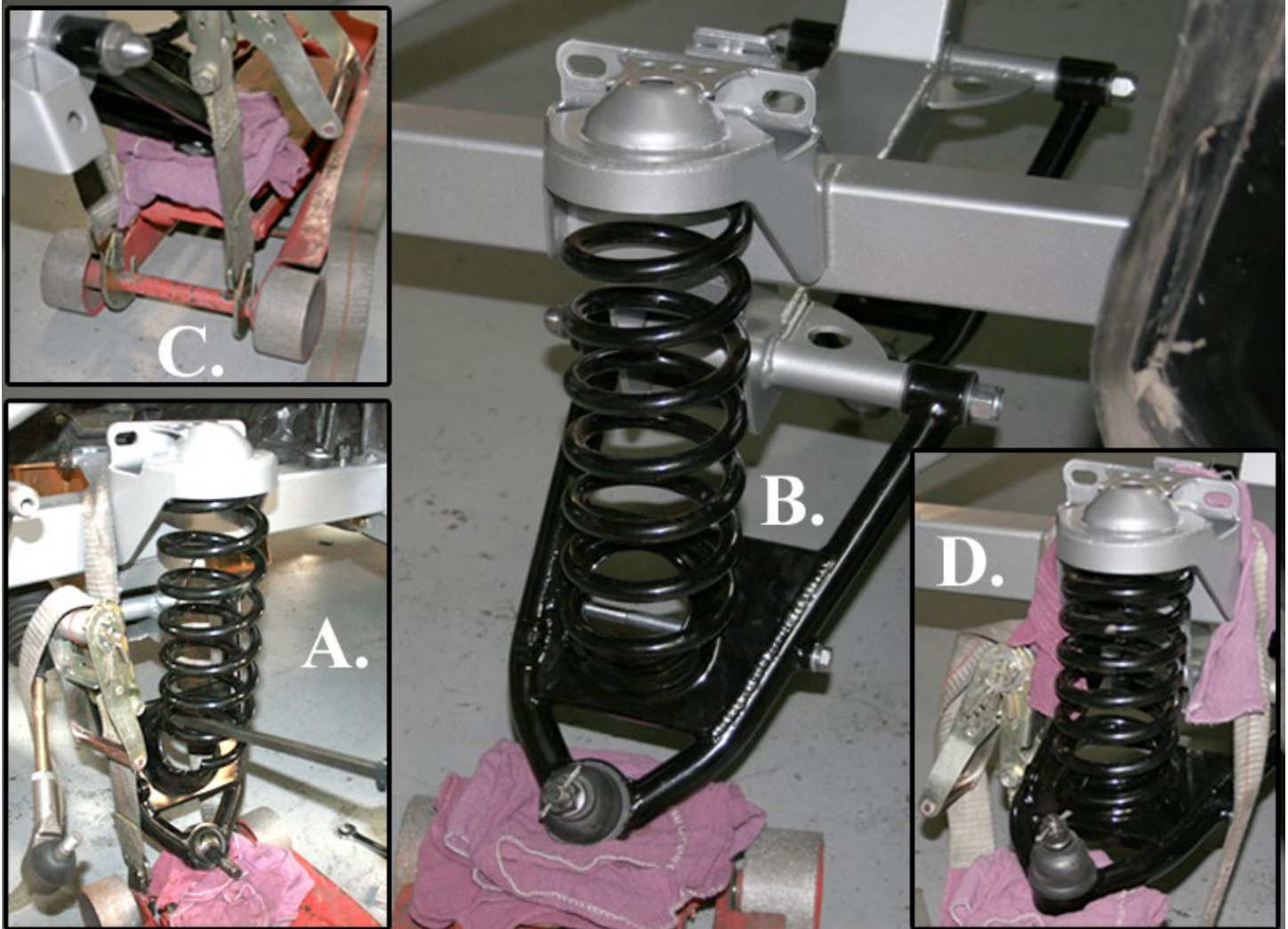

For Proper Installation of Coil Springs A Spring Compressor is needed

Here are some helpful hints for installing the springs without a spring compressor.

Installing the coil springs onto the front end

Before you Start:

***NOTE* It is best to use a spring compressor for this process. If you do not have a spring compressor this is an effective way to install your coil springs.**

1. **(Image A)** With the vehicle securely positioned on jack stands remove the grease fitting on the lower ball joint. Install the coil spring with the flat ground side up in the spring pocket and the pig tail end inserted onto the notched portion on the lower a-arm. Use a long screwdriver or flat bar inserted above the last coil and hooked through the coil pocket to hold the spring from coming out as you jack up the a-arm.
2. **(Image B)** Position the floor jack under the lower a-arm as shown with a clean towel protecting the finish.

Additional Components Needed:

Very strong ratcheting tie downs with hooks
Floor Jacks
Clean Towel

3. **(Image C)** Hook the ratcheting tie down to the front of the floor jack cross bar, then go up and over the upper a-arm mounting bracket. With the other end of the tie down hooked to the other side of the jack's crossbar. This keeps the frame from going up as you raise the a-arm.
4. **(Image D)** Slowly raise the jack until it is safe to remove the large screwdriver holding the spring in place. Keep raising the jack until the lower a-arm is high enough to fit the shock absorber into place.

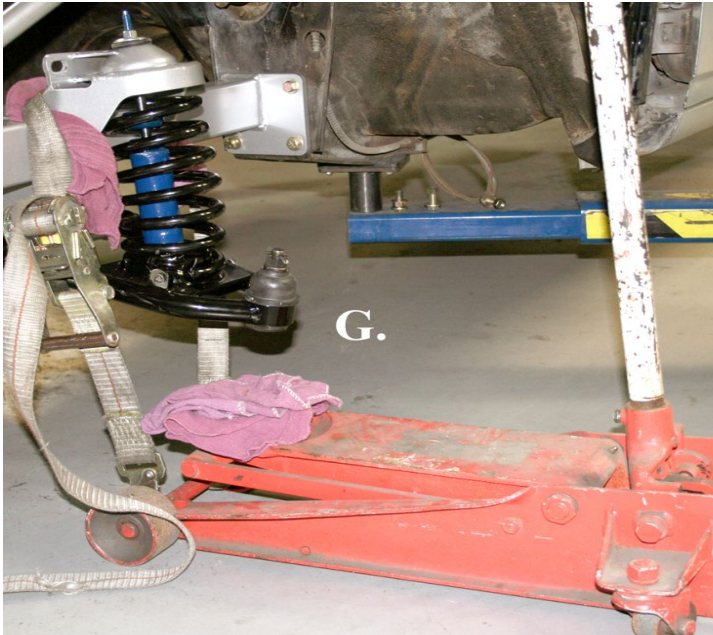
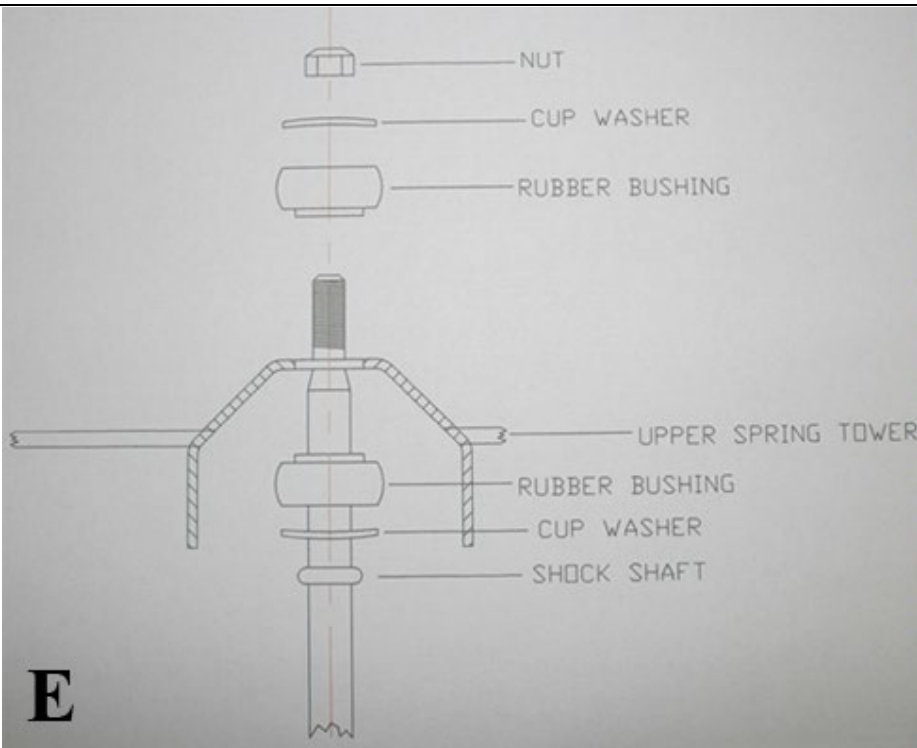

5. **(Image F)** Install the shock through the bottom of the lower a-arm with the shock stem going through the mounting hole in the upper hat. Align the lower shock sleeve with the shock bosses on the lower a-arm and install the 7/16" shock bolt and tighten

Note: If you have difficulty with the sleeve fitting between the bosses lightly sand the ends of the sleeve.

6. **(Image E)** Install the cup washers, bushings and nut on top of the shock stem and tighten. Carefully lower the jack and remove the ratchet tie down. Re-install your ball joint grease fittings. **(Image G)** This is what your installed spring will look like.

The spring that comes with the kit is a 300 lb. per inch rate and is identified with a green dot on the flat end.



****Addendum****

Ridetech Coil-Over upgrade

Turn the adjustment ring on the shock as far down as possible.

Install the spring onto the shock with the small tapered side of the spring down against the flat rubber insulator and adjuster ring



Place the shock onto the lower control arm and install the provided 1/2" button head bolt.



Install the nylock on the opposite side and tighten down



Use a T10 Torx head to remove the screw at the top of the shock/adjuster knob.



Remove the adjuster knob and screw and set it aside for now.

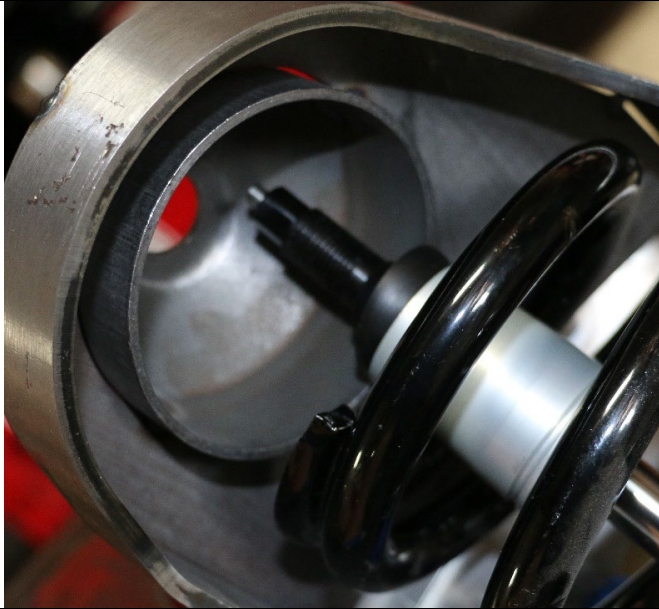

You can now lift the lower control arm and shock/spring combo up into the upper hat assembly. Align the shock shaft into the center hole of the upper hat.

This is where making sure the adjuster ring was all the way down or not will make all the difference. If it wasn't the stud will not protrude far enough to reinstall the top end of the shock.

NOTE Make sure the shock shaft is fully extended

Reinstall the concave insulator and thick washer on top of the upper hat assembly



Reinstall the nylock and tighten it down



Using the same T10 Torx you can now reinstall the adjuster knob and screw

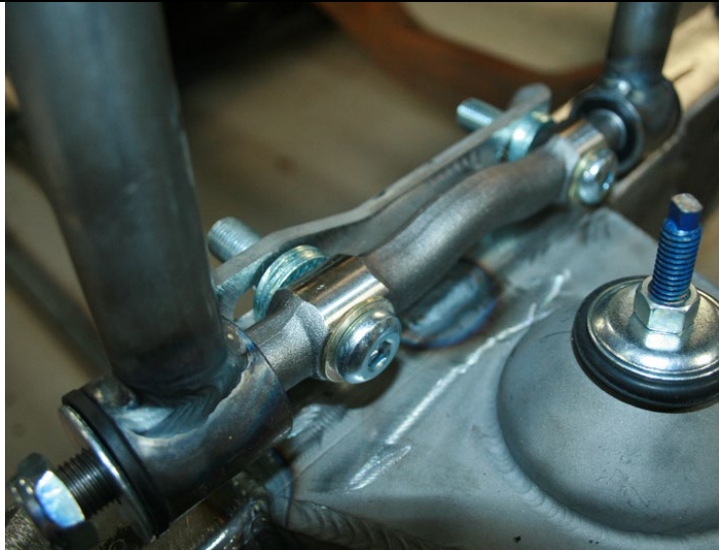

Installing the upper control arms:

Use four of the provided .090" thick washers between the tower and the control arm shaft on each bolt. The rest can be placed under the head of each bolt and under the lock nut. These spacers may need to be moved around when final alignment is performed. Once all the hardware is in place go ahead and set the bolts in the center of alignment slots and tighten down.

Note: Bolts are now 9/16" x 3" grade 8 hex head.

The slotted arm mount holes will make it easy to add in extra positive caster for power rack applications.



Installing the spindle assemblies:

Place the spindle onto the lower ball joint with the steering arm facing forward with the large I/D tie rod end taper facing down. (The tie rod end goes up into the spindle)

Place the ball joint washer first and then the castle nut. Torque the lower ball joint to 90 ft. lbs and install the cotter pin. The lower ball joint is a **MOOG K719**



Pull the upper control arm down onto the spindle. Place the ball joint washer first and then the castle nut. Torque the upper ball joint to 70 ft. lbs and install the cotter pin. The upper ball joint is a **MOOG K772**

NOTE Caliper Fittings:

GM Calipers = 10mm x 1.5

Wilwood Calipers = 1/8" NPT

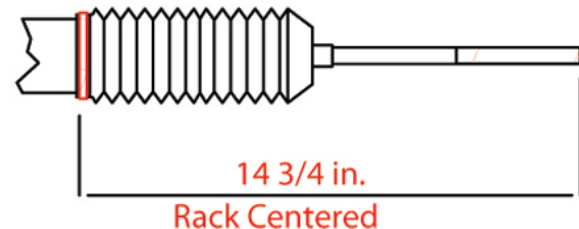
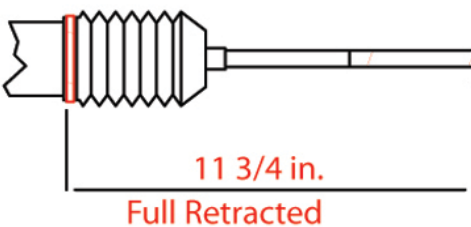
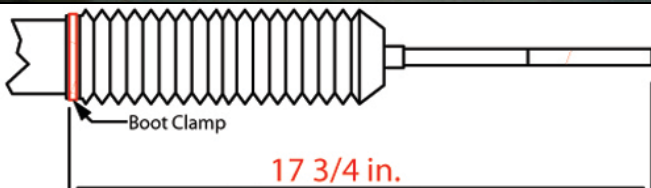

Centering the rack assembly:

The rack needs to be centered to allow equal steering left to right. On a bench, turn the pinion out to lock one way. Measure from a convenient point to the end of the inner tie rod. (This rack was 17 ³/₄). Turn the pinion of the opposite lock position and measure from the same point to the end of the same tie rod (11 ³/₄). 17 ³/₄ minus 11 ³/₄ = 6. Divided by 2 = 3 Add that number to the smallest measurement (11 ³/₄ + 3" = 14 ³/₄") and turn the pinion back till you get that measurement and your rack is centered.



Installing the rack and pinion:

Place the rack on the cross member brackets as shown. Use the supplied 5/8 hardware to fasten it into place. The picture shows a power rack that requires a 5/8" spacer between the rack and the mounting brackets. A manual rack bolts directly to the mounting brackets not needing these brackets.

Torque bolts to 90 ft. lbs

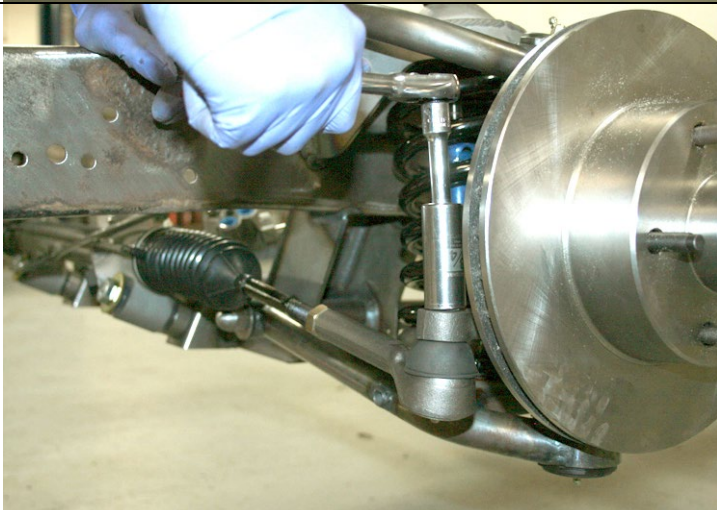

Install the jam nut and outer tie rod end onto both sides of the rack. With the rotors pointing straight ahead (0 toe) install the tie rod ends into the bottom of the steering arm. Torque the tie rod end to 60 ft. lbs. and install the cotter pin.

NOTE Rack & Pinion output shaft:

Manual rack = 9/16"x 26 spline

Power rack = 3/4" x 36 Spline through 4/2021

After 4/2021 = 3/4" Ford V.

Sweet Mfg. 401-51927 u-joint is recommended.



Installing the anti-sway bar:

Slide the lock ring collar over the bar on each side first. The split bushings go over the bar and then the aluminum blocks slide on over the bushings.

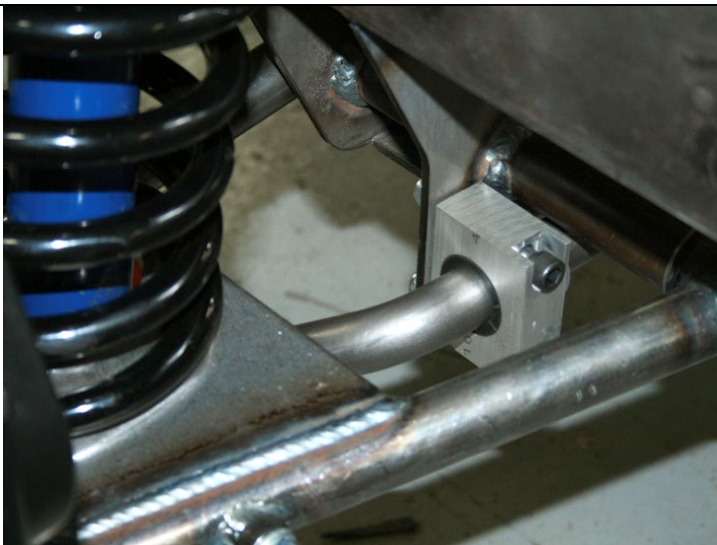

The anti-sway bar mounts to the rear of the cross member below the lower control arm pins. Use the supplied hardware to install the aluminum blocks onto the cross member. Torque to 35 ft lbs.

Center the anti-sway bar and lock down the set screws against the bushings.



The sway bar routes from behind the cross member under the control arms and hooks up to the front of the control arms. Use the supplied hardware to install the heim joints with the male on the bottom.

NOTE You can adjust the preload (or lack thereof) once the vehicle is ready to be driven. Disconnect one heim, place driver in the driver's seat, adjust the loose heim until it goes onto the anti-sway bar with zero load.



Setting up power steering

The rack ports are 9/16"-18 Pressure side & 5/8"-18 Return side
Unisteer 8026070 is a recommended fitting kit.

The recommended pump output is 800-1000psi and 2.0 gallons per minute. Exceeding this can cause the steering to feel "twitchy" and excess pressure can damage the rack.



Alignment specifications

Caster: Power rack 4-6 degrees positive
Manual rack 2-4 degrees positive

Camber: 0 Degree

Toe-in: 1/32 to 1/16 inch

Coil Spring Note: After 500-1000 miles the front springs will begin to break in. The lower control arms should be level to the ground or within a degree or two. You can now perform the final alignment. If the vehicle is still too high after 1000 miles it may be necessary to cut some of the coil off. Never cut more than a 1/4 coil off at a time.

Coil over note: Adjust the Coil-overs until the lower control arms are level to the ground. You can now perform the final alignment.

AXLE STUD SIZES:

4.5" Bolt circle rotors = 1/2"x20('75-'80 Ford Granada)

4.75" Bolt circle 10.5" rotors = 12mmx1.5('82-'87 Camaro)

4.75" Bolt circle 11" rotors = 7/16"x20('75-'80 Granada redrilled)

ALL Wilwood hubs = 1/2"x20

No returns or exchanges without a RMA#.

Packages must be inspected upon receipt & be reported within 10 days.

If you are missing parts from your kit, TCI Engineering will send the missing parts via FedEx or U.S. mail ground.

Returned packages are subject to inspection before replacement/refund is given
(Some items will be subject to a 15% restocking fee)

Thank you for your business!

